



Emotron DCM Control Unit



Instruction manual
English

Contents

| | | |
|----------|---|-----------|
| 1 | Inside the Box..... | 1 |
| 2 | Safety | 3 |
| 3 | Introduction | 5 |
| 3.1 | Description | 5 |
| 4 | Getting Started | 7 |
| 4.1 | Please note the safety section | 7 |
| 4.2 | Connection and setup before start | 7 |
| 4.3 | Auto set performed at normal pumping - pumping water..... | 9 |
| 4.4 | Auto set performed at snoring – pumping a mix of air and water | 10 |
| 4.5 | Quick setup - flow chart..... | 11 |
| 5 | Installation..... | 13 |
| 5.1 | Choice of current transformer | 13 |
| 5.2 | The operator’s panel | 17 |
| 5.3 | Description of functions | 19 |
| 5.4 | Connection terminals | 23 |
| 6 | Single-Pump System Installation | 25 |
| 6.1 | Single-pump system connection..... | 26 |
| 6.2 | Detailed setup for single-pump system | 28 |
| 6.3 | Adjustment of stop level..... | 30 |
| 6.4 | Start conditions and pause time adjustment | 30 |
| 6.5 | Returning to the default settings..... | 31 |
| 7 | Dual-Pump System Installation | 33 |
| 7.1 | Dual-pump system connection | 34 |
| 7.2 | Detailed setup for dual-pump system (always use two Emotron DCMs)..... | 36 |
| 7.3 | Returning to the default settings..... | 38 |

| | | |
|-----------|--|-----------|
| 8 | Protection and Alarm | 39 |
| 8.1 | Phase sequence (F1) | 39 |
| 8.2 | Phase asymmetry (F2) | 39 |
| 8.3 | Checking the current (F3) | 40 |
| 8.4 | Operating fault (F4) | 40 |
| 8.5 | Temperature input (F5)..... | 40 |
| 8.6 | Undervoltage (LU)/Overvoltage (OU) alarm | 41 |
| 9 | Troubleshooting | 43 |
| 10 | Technical Data | 45 |
| 10.1 | EU (European Union) specifications..... | 48 |
| 10.2 | US specifications | 49 |
| 10.3 | Canada specifications..... | 49 |
| 11 | Window Parameters | 51 |
| 12 | Service | 57 |
| 13 | Appendix | 59 |

1 Inside the Box

Please check the delivery. Despite the fact that all products from CG Drives & Automation are carefully inspected and packed, transport damage may occur:

- Your shipment should contain the Emotron DCM, a current transformer, 2x terminal covers (option*) and this instruction manual.
- Check carefully that the equipment ordered complies with the pump motor's input voltage and that the current transformer rating is as stated on the delivery note.
- Check that the contents have not been damaged during transport.
- If something is missing, or has been damaged, contact the supplier as well as the forwarding agent within 48 hours of receipt.

NOTE: If in doubt contact your supplier before installing or commissioning the product.

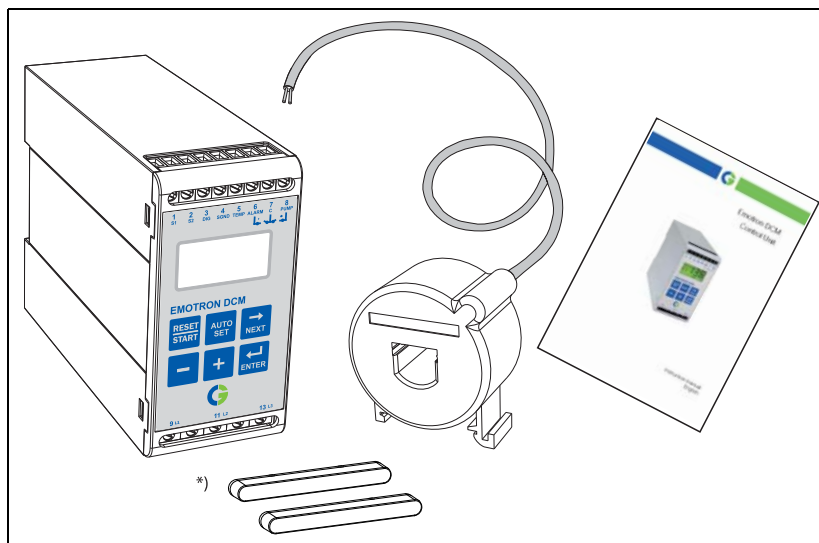

2 Safety

- Study this manual thoroughly before installing and using the Emotron DCM.
- The Emotron DCM must be installed by qualified personnel.
- Always disconnect supply circuits prior to installing.
- The installation must comply with standard and local regulations.
- Pay special attention to the information in this chapter and the parts marked WARNING and CAUTION in the chapter on operation.
- Check that the Emotron DCM and the equipment are correctly connected before being taken into use.
- Should questions or uncertainties arise, please contact your local sales outlet or see Chapter 12 page 57, Service.
- Faults that arise due to faulty installation or operation are not covered by the warranty.

NOTE: Removing or tampering with the seal on the housing will invalidate the warranty.

3 Introduction

This instruction manual describes the installation and commissioning of the Emotron DCM. The Emotron DCM is a control unit that remotely controls submersible pump equipment. Level sensors are not needed to initiate start and stop. The pump stops automatically when it begins to snore (draw air), when the pit has been pumped free from water. During a pumping operation, the Emotron DCM measures the length of the run period and uses this to determine the length of the rest period. The longer the run period, the shorter the rest period. As a result the run and the rest periods are continuously adapted to the rate of flow.

Two Emotron DCM can be connected in parallel to control two submersible pumps and allow independent operation and display of monitored values (see Chapter 7).

This instruction manual contains complete instructions for the installation and use of the Emotron DCM. Please read the entire manual before installing or using the DCM. Pay special attention to the Safety chapter in this manual and the parts marked WARNING and CAUTION.

3.1 Description

The Emotron DCM measures the input power by measuring voltage and current. This gives a reliable measurement of pump motor load over the total load range.

As an option a level switch can be used to trigger a start; either to override the pause time in case of high level or as the sole means to trigger a start.

The Emotron DCM is connected to the pump motor supply cable with a type CTM current transformer. The same Emotron DCM is suitable for small and large induction pump motors and the only accessory needed is the CTM current transformer (a primary standard current transformer is also necessary when the motor current is greater than 100 A).

The Emotron DCM is enclosed in a recyclable PC/ABS plastic housing. At the front is the operator's panel which comprises an LCD display and a set of six keys. The connection terminals are at the top and bottom of the unit front panel. The unit should be mounted on a standard DIN-rail.

The Emotron DCM is very easy to use. The "Auto set" function makes it possible to adjust the unit (stop level) automatically by pressing just one key.

The Emotron DCM always stops the pump as soon as it starts to snore (draw air) and restarts it after a calculated pause time or in response to a high-level switch-over.

The Emotron DCM is able to check:

- Phase sequence.
- Phase voltage asymmetry.
- Current from current transformer(s).
- Temperature on pump motor.
- Undervoltage and Overvoltage (at start up).

The Emotron DCM gives information about:

- Delay time before restarting after the pump has stopped.
- Pumping time since the latest pump start.
- High-level pumping time since the pump started as a result of high-level switch-over.
- Measured power as a percentage of the DCM's measurement range.
- Measured voltage.
- Measured peak power as a percentage of the DCM's measurement range.
- Time counter for total pumping time.
- Start counter - total number of times pump has started.

The Emotron DCM can be connected in parallel for a dual-pump system:

- Alternating
- MASTER/SLAVE function
- If there is a breakdown in one of the pumps, the other pump starts to operate.

4 Getting Started

4.1 Please note the safety section

1. Pay special attention to the safety section in this manual and parts marked WARNING and CAUTION.
2. Check that the pump motor/supply voltage corresponds to the values on the Emotron DCM product label at the side of the unit.
3. Make a note of the pump motor's rated current from its nameplate. Confirm that the current transformer(s) supplied is of the correct size according to Table 1, on page13 and Table 2, on page15 in this manual.

4.2 Connection and setup before start

1. Connect the Emotron DCM according to Chapters 5 and 6 and Fig. 13 (alternatively, for dual-pumps, Chapter 7 and Fig. 15 and 16).
2. Make sure all safety measures have been implemented and switch on the supply voltage.
3. Follow Quick setup - flow chart Fig. 4, page 11 for single-pump system and Fig. 5, page 12 for dual pumps.

The purpose of Getting Started is to achieve quick setup and to initiate the stop function. The Emotron DCM stops the pump when the water level has dropped to such a low level that the pump begins to snore (draw air). On intake of air the pump motor power drops below the stop level (see Fig. 1, page 8 and Fig. 2, page 9) and then the Emotron DCM stops the pump.

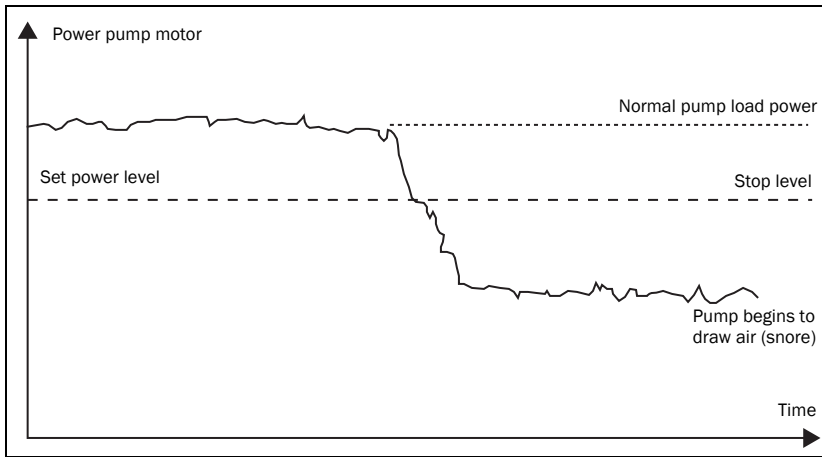

Fig. 1 Pump operation

If the Emotron DCM has been used previously, some parameters may have been changed. In such a case, go to Chapter 6 and perform a complete setup for single-pump system installation (alternatively, Chapter 7 for dual-pump system installation).

On the following pages is a description for the single-pump setup in general. In the event of an alarm during setup, see Chapters 8 and 9. For dual-pump setup, see Chapter 7, Dual-Pump System Installation.

4.3 Auto set performed at normal pumping - pumping water

1. Check that the amount of water is sufficient for pumping about 30 seconds without snoring.
2. Switch on the supply voltage to the Emotron DCM and set any pump system control equipment to the on position, “1” or Auto. The pump should now be pumping water without snoring. If the pump does not start, press the **RESET START** button on the Emotron DCM.
3. Step with the **→ NEXT** button to window 13 and check that the line is shown at the top of the display (°). If not, press **-**, then press **↵ ENTER** to confirm.
4. When the pump is working in steady state, press **AUTO SET** until “SEr” is shown on the display. The stop level is now set.

The stop function is now initiated and the Emotron DCM controls the pump. Adjustments can be made according to Section 6.2, page 30. See also section 6.3 and 6.4.

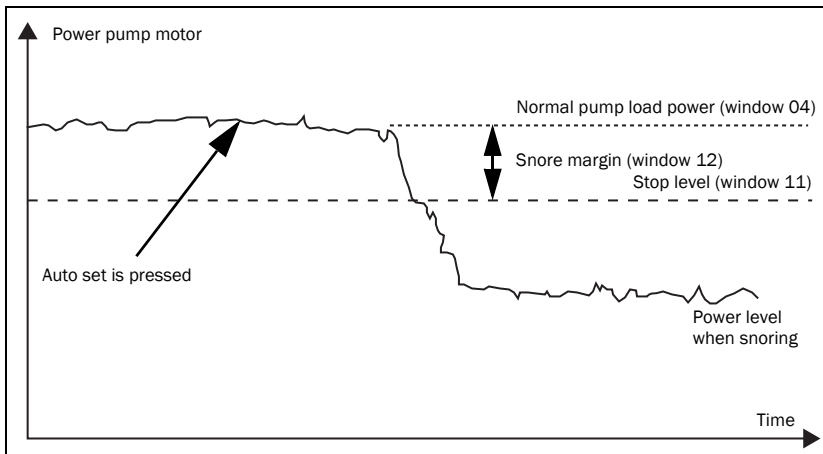

Fig. 2 Auto set performed at normal pumping

4.4 Auto set performed at snoring – pumping a mix of air and water

1. Set the pump system control equipment to the off position or “0”, and switch on the supply voltage to the Emotron DCM.
2. Step to window 13 with the **→ NEXT** button and press **-** so that the line is shown at the bottom of the display (). Then press **↵ ENTER** to confirm the setting. The Emotron DCM is now ready for Auto set at snoring.
3. Set the pump system control equipment to the on position, “1” or Auto to start the pump. If necessary, press **RESET START** to start the pump.
4. Run the pump until it starts to snore.
5. Press **AUTO SET** until “SEt” is shown on the display. The stop level is now set, thus stopping the pump when snoring.

The stop function is now initiated and the Emotron DCM controls the pump. Adjustments can be made according to Section 6.2, page 30. See also Sections 6.3 and 6.4.

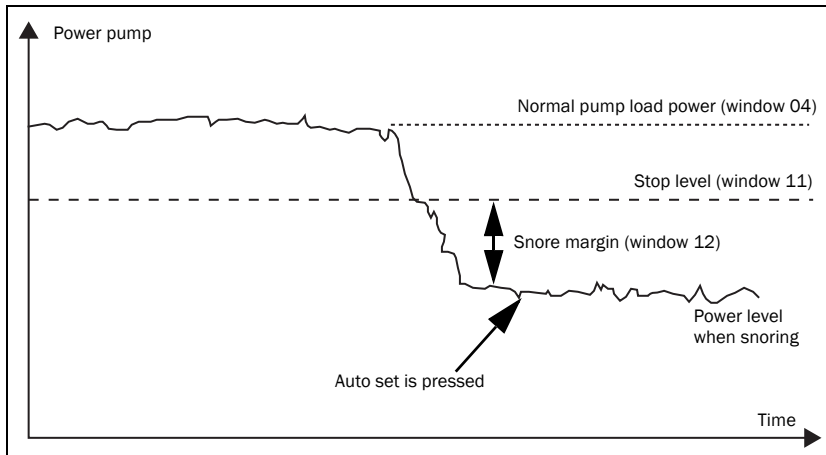

Fig. 3 Auto set performed at snoring

4.5 Quick setup - flow chart

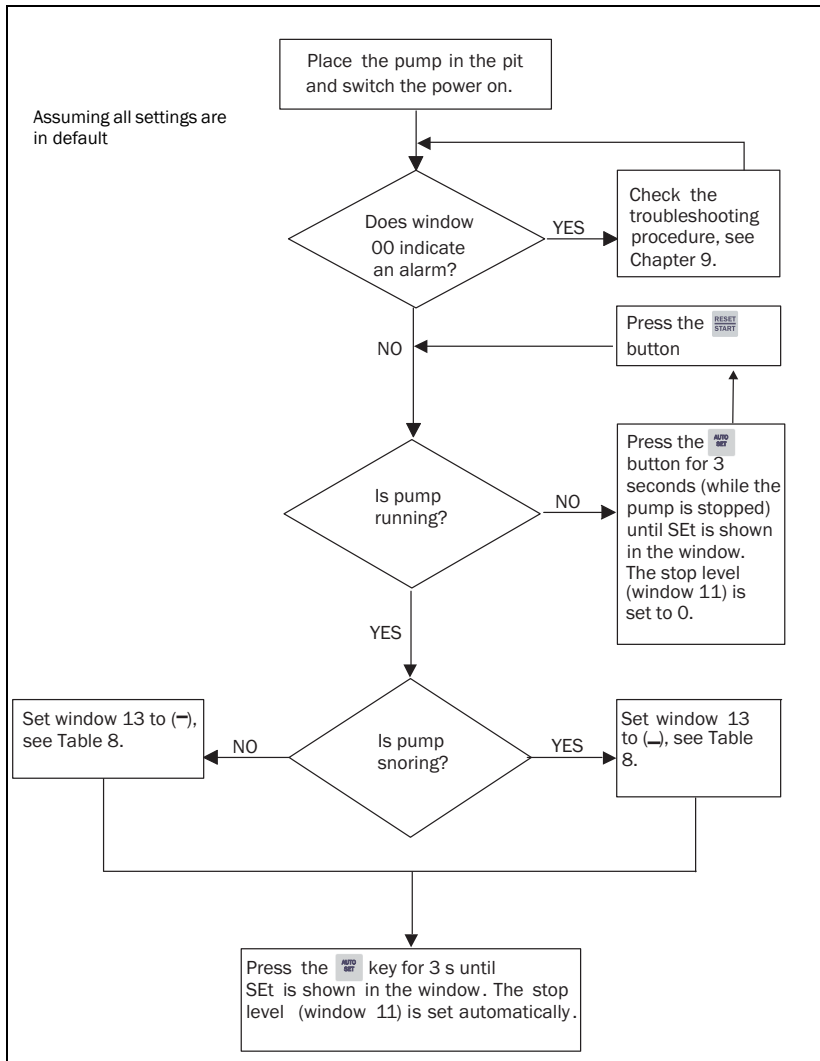

Fig. 4 Quick setup for single-pump system (the pump will start and stop during setup)

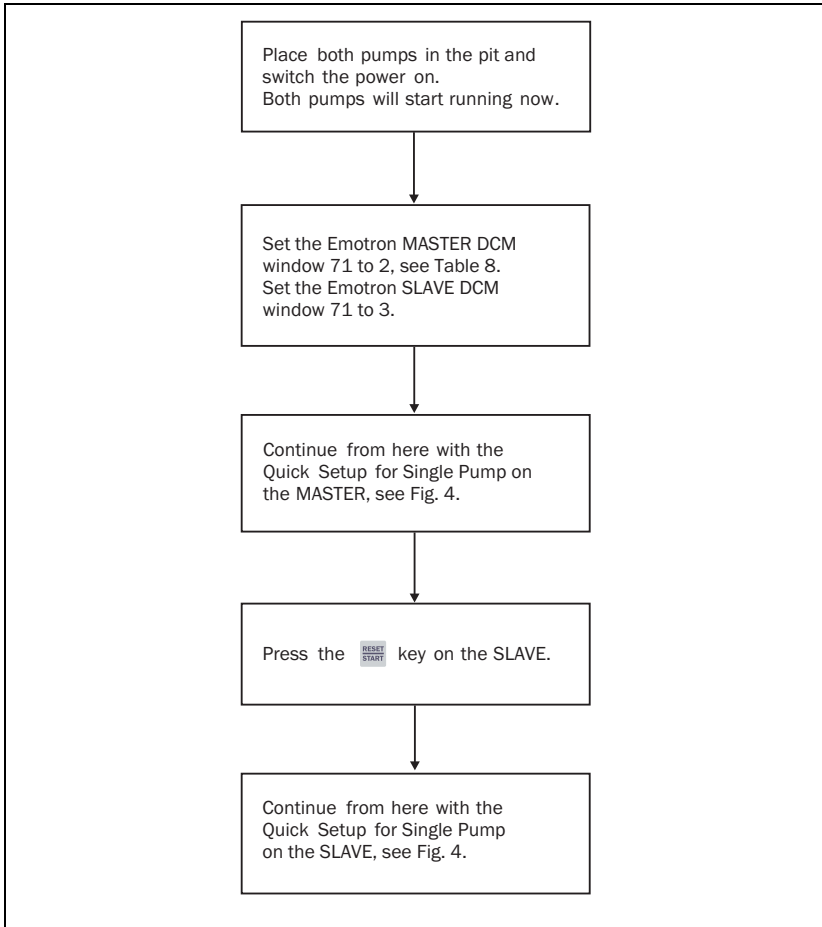

Fig. 5 Quick setup for dual-pump system (the pumps will start and stop during setup).

5 Installation

The Emotron DCM may only be installed and commissioned by an authorized person according to standard and local regulations. Pay special attention also to the Safety chapter in this manual and the parts marked WARNING and CAUTION.

The Emotron DCM should be mounted on a standard DIN rail 46277, 35 mm. See “Technical Data” for maximum operating temperature range, dimensions etc. Before installing, make sure that no voltage is applied to the equipment and that the voltage rating of the Emotron DCM, as shown on the rating plate on the side of the unit, corresponds to the motor/line voltage.

5.1 Choice of current transformer

Depending on pump motor size, the Emotron DCM should be used with one or two current transformers. For pump motors with a rated current up to 100 A, use a single CTM current transformer. The possible combinations of CTM current transformers and the number of windings are listed in Table 1.

Table 1 Table for selection of current transformer for motors with a rated current up to 100 A

| Rated motor current | Choice of current transformer and number of windings for different pump motor sizes. | | | |
|---------------------|--|--------|--------|---------|
| | CTM010 | CTM025 | CTM050 | CTM0100 |
| 0.4 to 1.0 A | 10 | | | |
| 1.01 to 2.00 A | 5 | | | |
| 2.01 to 3.0 A | 3 | | | |
| 3.1 to 5.0 A | 2 | | | |
| 5.1 to 10 A | 1 | | | |
| 10.1 to 12.5 A | | 2 | 4 | |
| 12.6 to 25 A | | 1 | 2 | |
| 26 to 50 A | | | 1 | |
| 51 to 100 A | | | | 1 |

NOTE: The current transformer must be linked to the phase connected to terminal 9 (L1).

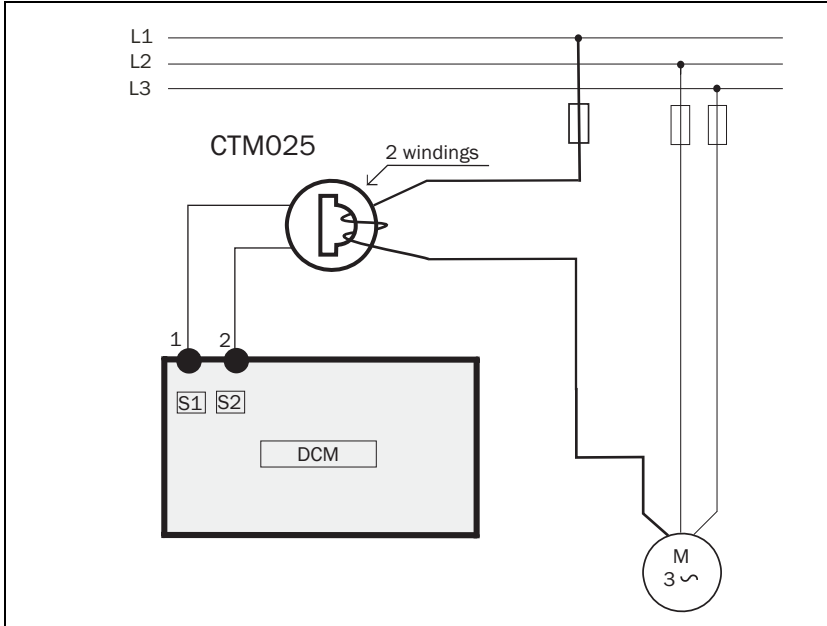

Fig. 6 Example: CTM 025 with 2 windings for a 12 A pump motor

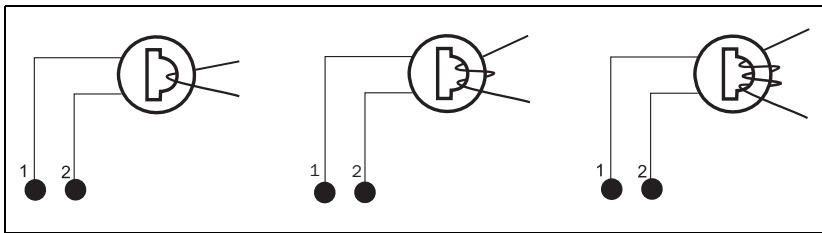

Fig. 7 Example: 1, 2 and 3 windings, see also note on page 14

For larger motors (rated current > 100 A), use two current transformers - one outer, standard transformer, and one CTM010 with two windings. Table 2 shows the choice of transformers (standard + CTM010) and number of windings for currents exceeding 100 A.

Table 2 Table for selection of current transformers for motors with a rated current greater than 100 A

| Rated motor current | Current transformers Number of windings |
|----------------------------|--|
| 101 to 150 A | 150:5 + CTM010 1 + 2 |
| 151 to 250 A | 250:5 + CTM010 1 + 2 |
| 251 to 500 A | 500:5 + CTM010 1 + 2 |
| 501 to 999 A | 1000:5 + CTM010 1 + 2 |

The following examples illustrate the choice of current transformer(s):

Example A. Pump motor has a rated current of 6.9 A. According to Table 1, choose CTM010 with one (1) winding.

Example B. Pump motor has a rated current of 108 A. According to Table 2, choose a standard current transformer 150:5 with one (1) winding and a CTM010 with two (2) windings.

NOTE: The current transformer must be linked to the phase connected to terminal 9 (L1).

In order to ensure accurate calibration of the Emotron DCM, it is essential that you use the correct CTM (and, additionally, a standard current transformer) and apply the exact number of wirings in accordance with the tables above.

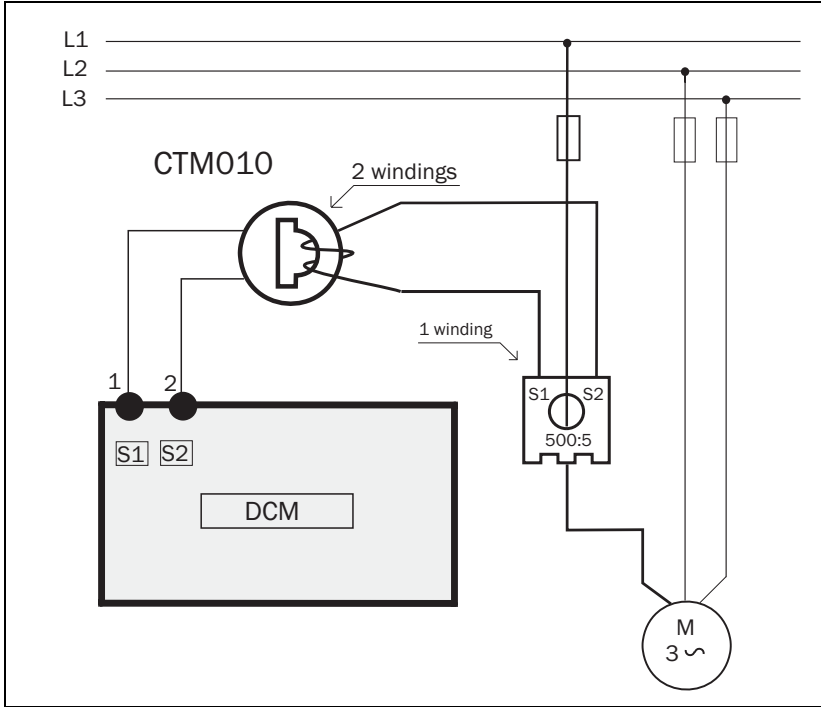

Fig. 8 Example of a CTM 010 with 2 windings and a primary transformer 500:5 with 1 winding for a 260 A pump motor. See also note on page 15

NOTE: The current transformer(s) must be used according to Table 1 or Table 2. Make sure to apply the correct number of winding to the transformers.

5.2 The operator's panel

The operator's panel comprises an LCD display and a set of six keys on the front panel of the Emotron DCM. The display provides five digits and eight symbols, see Fig. 9. The symbols are explained in Table 3, page 18.

The two smaller digits on the left of the display show the window number. Each window (e.g. 00, 01, 02) contains a parameter (e.g. 125, 0.99, on, OFF) whose value is shown by the three larger digits or characters to the right. When the value is greater than 999 all five digits are used to display the parameter value, alternating with the window number. For example, the window number 21 is displayed for 2 seconds and then the value 12345 is displayed for 2 seconds.

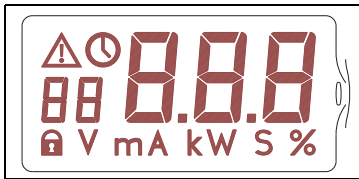

Fig. 9 The display

- When the Emotron DCM is turned on, a self test is performed for 3 seconds and all characters and symbols on the display are shown.
- During an alarm the entire display flashes.
- If “oor” (out of range) is shown on the display, this means that the value is too high to be shown on the display.

Table 3 Symbols on the LCD display



| Symbol | Meaning |
|---|-------------------------------------|
|  | Flashing when alarm triggered. |
|  | Indicates when the value is a time. |
|  | Parameter settings are locked. |
| V | Volt |
| mA | Milliampere |
| m | Minutes |
| S | Seconds |
| % | Percent |

Table 4 Function of the keys

| Key | Function |
|-------------|--|
| RESET/START | Resets a latched alarm/Starts the pump motor. |
| Auto set | The stop level is automatically set when the button is pressed for 3 s. |
| NEXT | Proceed to the next window. |
| - | Decrease the displayed value. For fast incremental decrease, press the button for 6 s. |
| + | Increase the displayed value. For fast incremental increase, press the button for 6 s. |
| ENTER | Confirms the adjustments made. |

5.3 Description of functions

The menu structure is described in Fig. 10, page 20. Detailed information is to be found in Table 8, page 53.

On delivery, the Emotron DCM is pre-programmed with the default settings shown in Table 8, page 53.

One minute after any front panel button is pressed, the Emotron DCM returns to:

- Window 00 if an alarm has been triggered.
- Window 01 if the pump is paused. When the DCM is SLAVE it displays ---.
- Window 02 if the pump is pumping. When the DCM is MASTER and its SLAVE is pumping it displays _ _ _.
- Window 03 if the pump is pumping and it started as a result of a high-level switch-over.

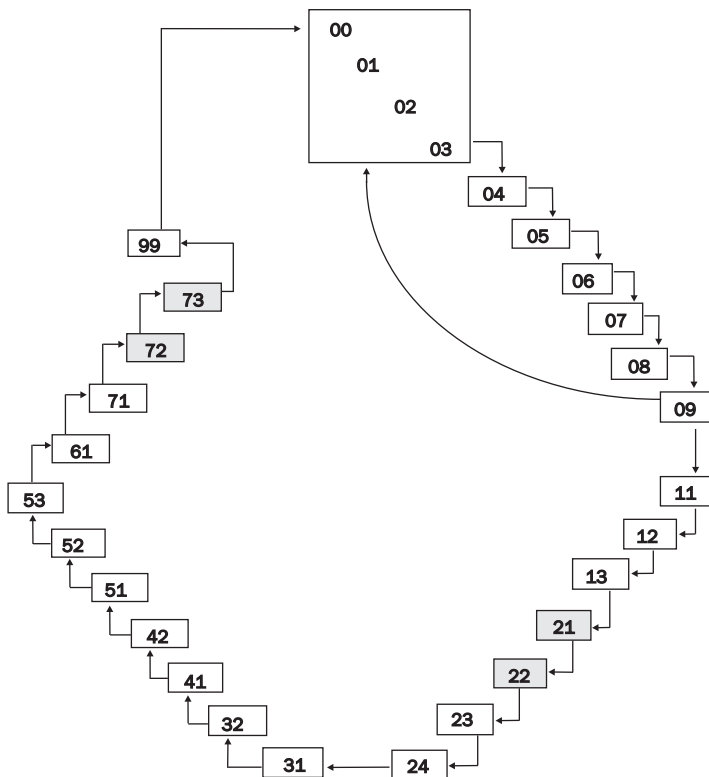

Fig. 10 Menu structure of the Emotron DCM (see also Table 8, page 53.). The windows 21, 22, 72 and 73 are not shown when the DCM is a SLAVE (dual-pump system).

NOTE: The Emotron DCM is designed to work with a pit volume which is \geq the capacity of the pump (in litres). The operator can decide at what pit volume the DCM should start pumping using window 21.

Start volume = pump capacity [litres/min] x time constant in window 21 [min]. Window 21 has a selectable value from 1.0 – 10.0 minutes.

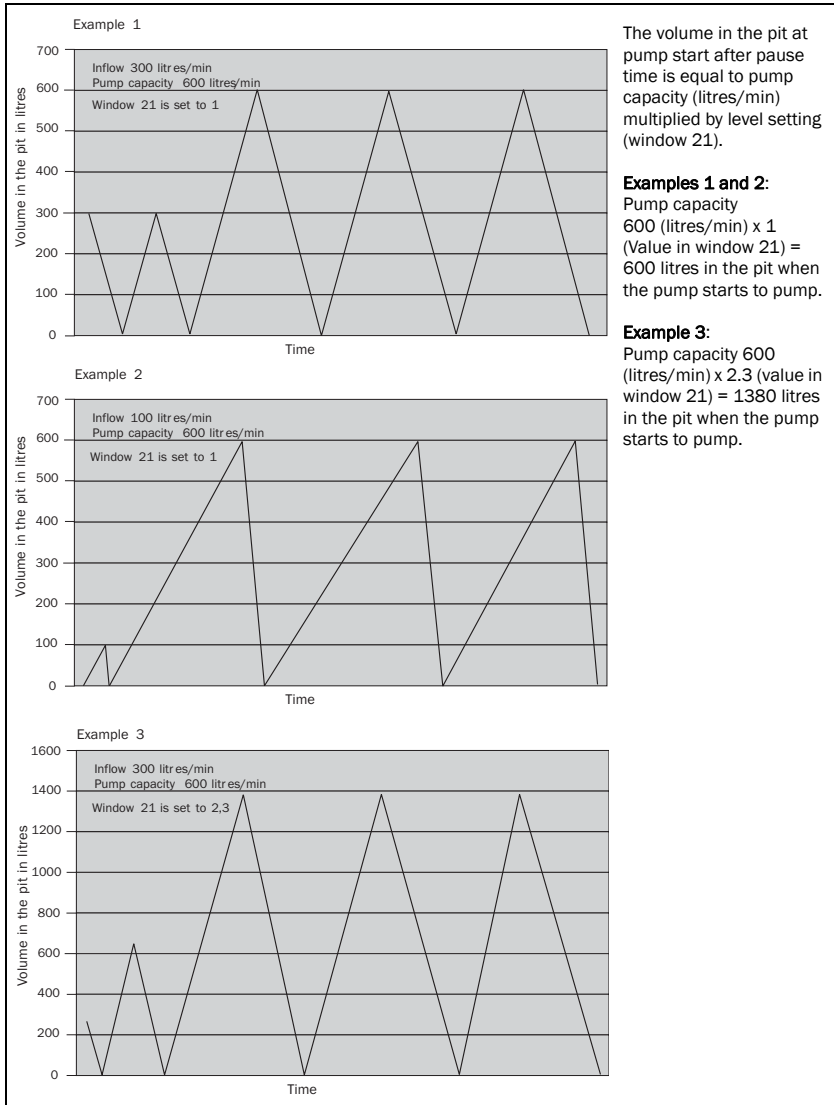

Fig. 11 Pump cycle example with different level settings in window 21

NOTE: See note on page 20.

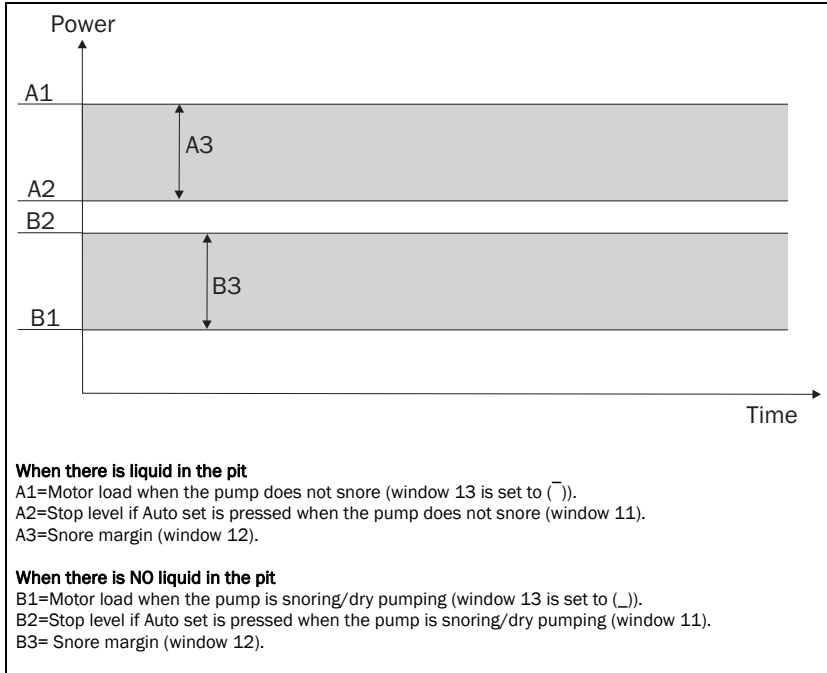

Fig. 12 Type of Auto set

5.4 Connection terminals

There are 13 connection terminals on the front panel of the Emotron DCM.

Table 5 Labelling and functions of connection terminals.

| Terminal | Label | Function |
|-----------------|--------------|--|
| 1 | S1 | Current transformer input (CTM xxx), blue wire. |
| 2 | S2 | Current transformer input (CTM xxx), brown wire. |
| 3 | DIG | Digital input for closing contact. High-level switch or external reset/Auto set. In dual-pump applications terminal 3 is also used for communication between the two DCMs. |
| 4 | SGND | Signal ground for terminals 3 and 5. |
| 5 | TEMP | Input for motor thermistor (PTC), thermal contact, and/or any voltage-free opening contact or motor protection relay. |
| 6 | ALARM | Alarm relay output. (The DCM MASTER uses this terminal in series with the high-level switch. |
| 7 | C | Common input for alarm and pump relay. |
| 8 | PUMP | Operation of relay pump motor (control signals for start and stop equipment). |
| 9 | L1 | Supply voltage L1. |
| 10 | (not used) | |
| 11 | L2 | Supply voltage L2. |
| 12 | (not used) | |
| 13 | L3 | Supply voltage L3. |

6 Single-Pump System Installation



CAUTION!

Before carrying out any work, check that any automatic control equipment, etc., is disconnected from the power supply and cannot become live.

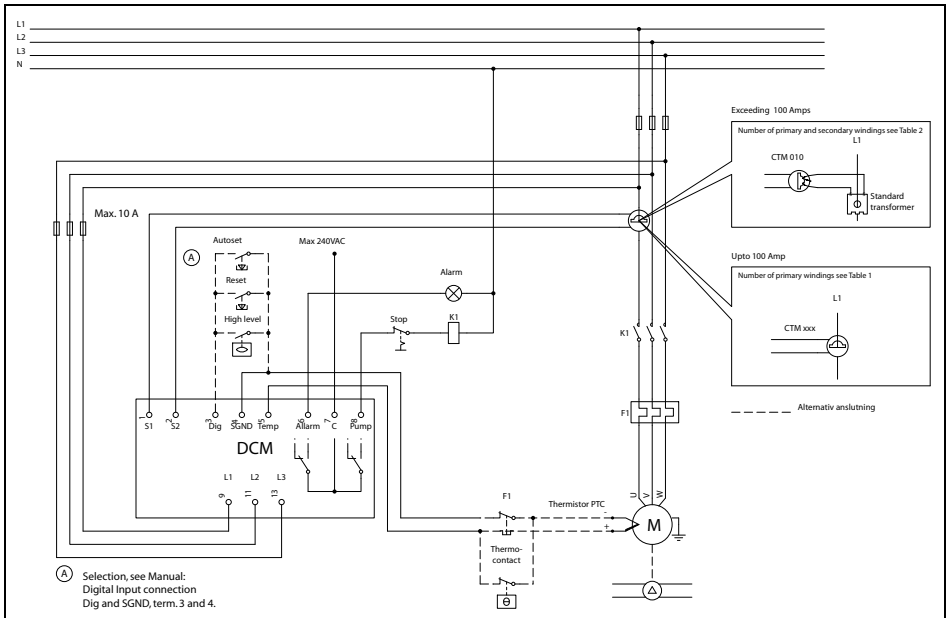

Fig. 13 Single-pump system installation example (alternatively see Chapter 13).

6.1 Single-pump system connection

6.1.1 Supply voltage connection (L1, L2 & L3)

Connect the Emotron DCM (3-phase installation only) directly to the pump motor supply cable via terminals 9 (L1), 11 (L2), and 13 (L3). Make the connection ahead of the contactor of the motor, to ensure that the DCM also receives power when the motor is not in use. When motor fuses larger than 10 A are used, the DCM (power consumption 6 VA) must be fused independently, see Fig. 13, page 25.

6.1.2 Current transformer connection (S1 & S2)

Connect the current transformer CTM xxx to terminal 1 (S1, blue wire) and terminal 2 (S2, brown wire). The transformer **MUST** be linked to the phase connected to terminal 9 (L1), see Fig. 13.

When two current transformers are used (for motors with a rated current greater than 100 A), always connect the CTM010 to the DCM and one outer standard current transformer with 2 primary windings through the CTM010, see Fig. 8 and 13 and Table 2, page 17.

NOTE: Before connecting the current transformer(s), study the choice of current transformers carefully to determine the correct number of windings. The current transformer **MUST be linked to the phase connected to terminal 9 (L1), see Fig. 13, page 25.**

In order to ensure accurate calibration of the Emotron DCM, it is essential that you use the correct CTM and apply the exact number of windings in accordance with Table 1, page 15 or Table 2, page 17.

6.1.3 Alarm relay connection (ALARM & C)

Terminals 6 and 7 are the alarm relay connections. Terminal 6 (ALARM) is the alarm relay output. Terminal 7 (C) is the common input for the alarm relay.

When powered off, the alarm relay is NC (normally closed). When powered on, NC or NO (normally open) can be selected, see Table 8, window 51.

6.1.4 Operation relay connection (PUMP & C)

Terminals 7 and 8 are the operating relay connections that control the start and stop equipment for the pump motor.

Terminal 8 (PUMP) is an operating relay output. Terminal 7 (C) is the common input for the operating relay, see Fig. 13, page 25.

When powered off, the operating relay is NO. When powered on, NC or NO can be selected, see Table 8, page 53 and window 52.

6.1.5 Digital input connection (DIG & SGND)

Terminals 3 (DIG) and 4 (SGND) are connections for a closing contact between DIG and SGND.

The three functions that can be initiated by the digital input are:

1. High-level switch (to enable immediate start of the pump).
2. External reset.
3. External Auto set.

See Fig. 13, Table 8, page 53 and window 53.

6.1.6 Temperature-measuring input connection (TEMP & SGND)

Terminals 4 and 5 are the temperature-measuring input and/or motor protection contact connections. The motor protection relay can be connected in series with the temperature sensor. Terminal 5 (TEMP) is for a PTC-type thermistor or thermo contact. Terminal 4 (SGND) is the signal ground for the temperature-measuring input. See Fig. 13, Table 8 and windows 31 and 32.

6.2 Detailed setup for single-pump system







WARNING!

The pump starts and stops during setup. Make sure that all safety measures have been implemented before switching on the supply voltage and starting the pump in order to avoid personal injury.



NOTE: To prevent involuntary starting and stopping of the pump during setup steps 1 to 13, disconnect the wire on terminal 8.

Setting up of the Emotron DCM

The steps below illustrate examples of how to program the DCM. When the power is turned on, press  to proceed to the next window, press  or  to increase or decrease the value, and press  to confirm the new value in each window. See Table 8. For quick setup, see Chapter 4.

Install the Emotron DCM according to Chapter 5, page 15.

1. Place the pump in the pit and switch the power on.
2. Check window 71 if the value is 1 (single-pump system).
3. In window 13 select the type of Auto set. Set the window to (–) if the pump is pumping without snoring (there is liquid in the pit). Set the window to () if the pump is snoring (no liquid in the pit) (see Fig. 2, 3 and 12).
4. In window 22 set the maximum pause time between 0-720 minutes. See section 6.4, page 30.
5. In window 23 set the required start-up delay between 1-170 s. Start-up delay time is the time between the pump starting and the time when snoring is detected (no liquid in the pit).
6. In window 24 set the required stop delay between 1-90 seconds. The stop delay is the time between the pump starting to snore and the time when the pump motor stops.
7. In window 31, if the pump has a temperature sensor and/or motor protection, set the temperature monitoring to (on). If not, set the window to (OFF). See Section 8.5, page 42 and Fig. 13, page 25.

8. In window 32 if window 31 is set to (on), choose temperature alarm latched (on) or temperature alarm not latched (OFF). See section 8.5.
9. In window 41 the permitted phase asymmetry is set between 5% and 50%. Phase asymmetry monitoring is turned off by pressing -, when the window shows 5%. To turn the monitoring on again press + and select a value, see Section 8.2, page 41.
10. In window 42, if the window 41 value is between 5% and 50%, choose phase asymmetry alarm latched (on) or phase asymmetry alarm not latched (OFF). See section 8.2.
11. In window 51 set the alarm relay contact function to **NO** (normally open) or **NC** (normally closed), see Section 6.1.3, page 26.
12. In window 52 set the operating relay contact function, see section 6.1.4.
13. In window 53 set the required function for the digital input (DIG). Value: (1) high-level switch, (2) external reset, (3) external Auto set.
14. Connect the start and stop equipment to terminal 8, see Fig. 13, page 25.
15. Check that the pump is pumping in accordance with the setting in window 13 (set the stop level in window 11 to 0 (default) if the pump stops before or during the Auto set). Press the  button and hold for 3 seconds until "SEt" appears in the window. The stop level (window 11) becomes measured power (window 04) minus snore margin (window 12) if window 13 is set to (¯). The stop level (window 11) becomes measured power (window 04) plus snore margin (window 12) if window 13 is set to (_), see Fig. 2, 3, 12 and 14.
16. Change the level setting in window 21 between 1-10 for shorter or longer pump cycles and levels in the pit. A low value gives shorter pump cycles and lower level in the pit. See Fig. 11 and 14.
17. It is possible to avoid unintentional changes of set parameters. Set window 09 to 369 and confirm with . A padlock is shown in the window. If the value 369 is re-entered in window 09, confirmed by , the settings are unlocked.

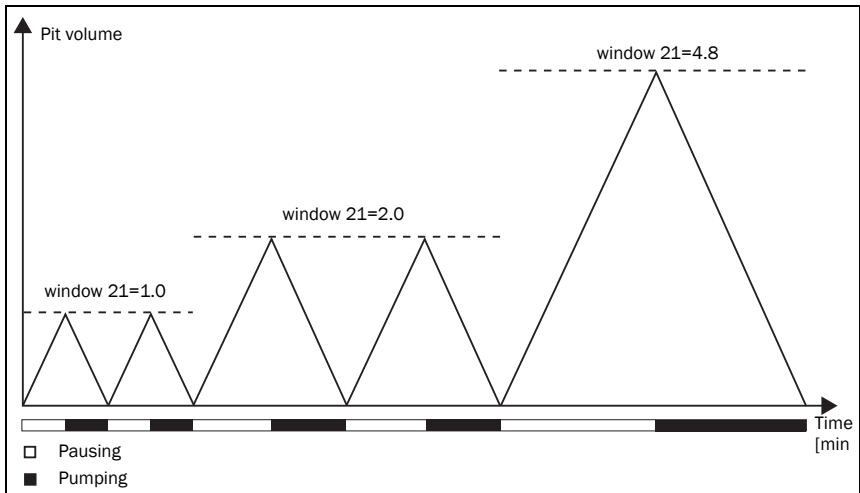

Fig. 14 Relative volume in the pit at pump start

6.3 Adjustment of stop level

The stop level can always be adjusted in the following way:

1. Change the snore margin (window 12) and perform a new Auto set. The new stop level will be set in relation to the snore margin. See examples in Fig. 2, page 11 and Fig. 3, page 12.
2. Change the stop level directly in window 11.

6.4 Start conditions and pause time adjustment

In normal operation there are two starting options:

1. Pump start after remaining pause time (window 01).
2. Pump start at high level switch (window 53 = "1"). This requires connection of a high-level switch according to Section 6.1.5, page 27.

The pump will also start if a non-latched alarm disappears or the  button is pressed during pause.

Calculation of pause time is based on previous pumping and pause times and is controlled by the two parameters, level setting (window 21), and maximum



pause time (window 22). The parameters can be adjusted to achieve desired magnitudes of pause times, start level and number of starts per hour. See Fig. 11, page 23, and 14, page 30.

The level setting in window 21 is set for shorter or longer pumping and pause cycles. Higher values increase the calculated pause time and the amount of accumulated water.

The level setting is best adjusted after a few pumping cycles in order to adjust the pause time, and hence the start level in the pit. See schematic pump cycle example in Fig. 11 and 14.

Maximum pause time for the pump is set in window 22. The calculated pause time will be limited to this value. In some applications the inflow may increase rapidly during a pause. To prevent overflow in these situations the maximum pause time can be set in accordance with the circumstances.

6.5 Returning to the default settings

1. To return to the default settings go to window 99.
2. If any value differs from the default values (see Table 8). “U_{sr}” (set by the user) is displayed in the window.
3. Press  to return to the default settings. “dEF” (default setting) is shown in the window. Confirm by pressing .

NOTE: Also, windows 6, 7 and 8 are set to 0.

7 Dual-Pump System Installation



CAUTION!
Before carrying out any work, check that any automatic control equipment, etc., is disconnected from the power supply and cannot become live.

NOTE: Some useful hints and examples are given in Chapter 6, page 27, Single-Pump System Installation.

NOTE: The dual-pump DCM system must not be installed in a pit of extremely small diameter or width. This will result from time to time in the DCMs failing to detect the stop/minimum level.

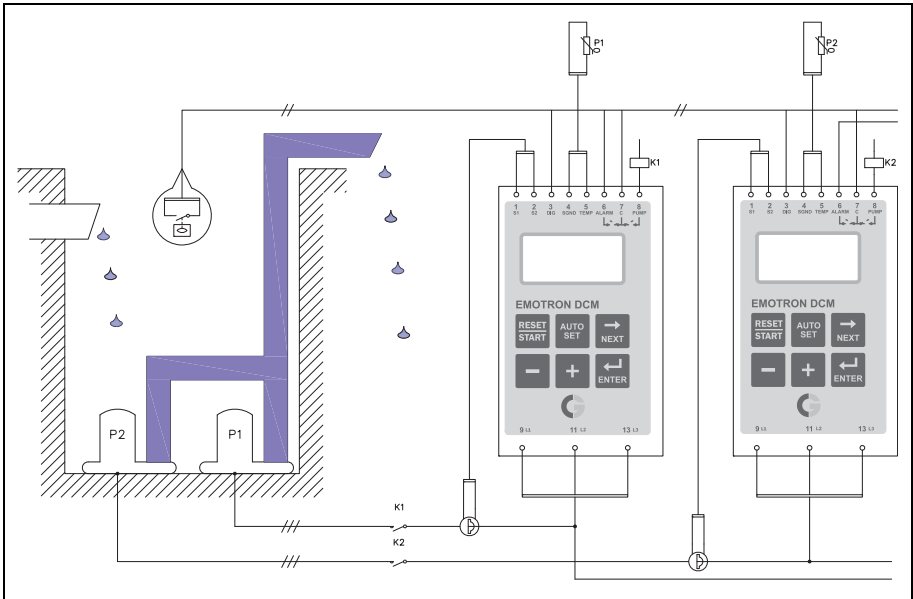

Fig. 15 Dual-pump application

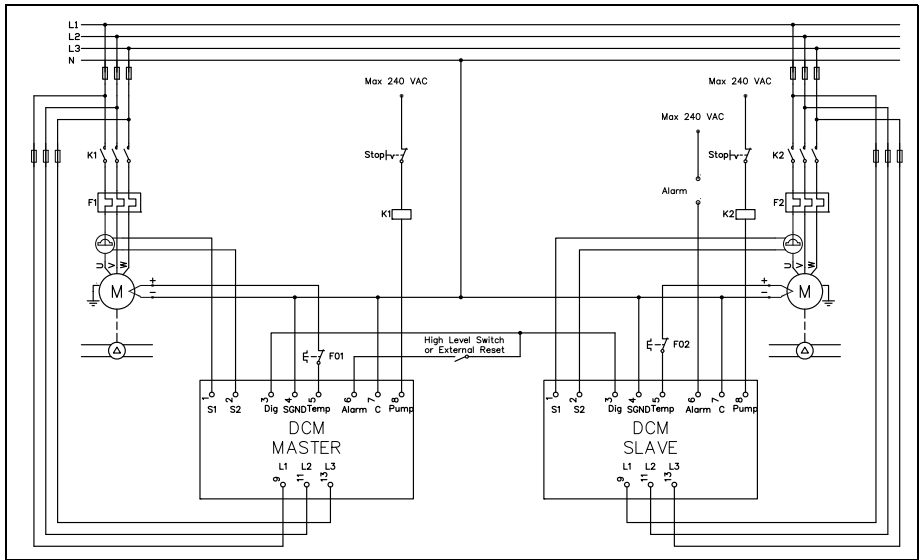

Fig. 16 Dual-pump example (alternatively, see the Appendix, Chapter 13)

7.1 Dual-pump system connection

(Parallel connection of two Emotron DCMs)

7.1.1 Dual-pump supply connection (L1, L2 & L3)

Connect the main voltage from each pump to the respective DCM as described in Section 6.1.1, page 28. See Fig. 16.

7.1.2 Dual-pump current transformer connection (S1 & S2)

Connect the current transformers (CTMs) from each pump to the respective DCM as described in Section 6.1.2, page 28. See Fig. 16.

7.1.3 Dual-pump alarm relay connection (ALARM & C)

Terminals 6 and 7 on the DCM SLAVE are the alarm relay connections. These terminals indicate an alarm if a fault is detected by the DCM MASTER or the DCM SLAVE. See Fig. 16. When powered off, the alarm relay is NC (normally closed). When powered on, NC or NO (normally open) can be selected. See Table 8, page 53, window 51.

7.1.4 Dual-pump communication and digital input connection (DIG & SGND)

Terminals 3 (DIG) and 4 (SGND) are connections for closing contacts and for communicating between the DCM MASTER and the DCM SLAVE. The digital input can be used for high-level switch or external reset. The high-level switch must be connected in series with the DCM MASTER terminal 6 (ALARM) and terminal 3 (C). When external reset is chosen use the pulse signal. Connect terminal 3 (DIG) on the DCM MASTER to terminal 3 (DIG) on the DCM SLAVE. Connect terminal 4 (SGND) on the DCM MASTER to terminal 4 (SGND) on the DCM SLAVE. See Fig. 16 and Table 8, page 53, window 53.

7.1.5 Dual-pump operation relay connection (PUMP)

Connect the control signals for the start and stop equipment for each pump to the respective DCM as described in Section 6.1.4, page 29. See Fig. 16.

7.1.6 Dual-pump temperature-measuring input connection (TEMP & SGND)

Connect the temperature sensor and/or motor protection for each pump to the respective DCM as described in Section 6.1.6. See Fig. 16.

7.2 Detailed setup for dual-pump system (always use two Emotron DCMs)







WARNING!



The pumps start and stop during setup. Make sure that all safety measures have been implemented before switching on the supply voltage and starting the pumps in order to avoid personal injury.



NOTE: To prevent involuntary starting and stopping of the pumps during setup steps 1 to 14, disconnect the wire on terminal 8 on both DCMs.

Setting up of the Emotron DCM



The steps below illustrate examples of how to program the DCM. When the power is turned on, press  to proceed to the next window, press  or  to increase or decrease the value and press  to confirm the new value in each window. For quick setup, see Chapter 4.

1. In window 71 set the required function: dual-pump control MASTER (2) for one of the DCMs and for the other DCM dual-pump control SLAVE (3). The DCM MASTER must be the DCM that is wired for MASTER, see Fig. 16, page 34.
2. In window 72 on the MASTER DCM, set the condition for alternating the pumps. Alternate by each pump cycle (on). The SLAVE DCM starts only when the DCM MASTER shows fault codes (OFF).
3. In window 73 on the MASTER DCM, set the condition for pump start-up on the high-level switch. Both pumps start (on). One pump starts (OFF).
4. In window 13 select the type of Auto set (on both DCMs). Set the window to (∩) if the pump is pumping without snoring (there is liquid in the pit). Set the window to (∪) if the pump is snoring (no liquid in the pit); see Fig. 12, page 24.
5. In window 22 on the MASTER DCM, set the maximum pause time between 0 - 720 minutes.
6. In window 23 on both DCMs, set the required start-up delay between 1-170 seconds. Start-up delay time is the time between the pump starting and the time when snoring is detected (no liquid in the pit).

7. In window 24 on both DCMs, set the required stop delay between 1-90 seconds. Stop delay time is the time between the pump starting to snore and the time when the pump motor stops.
8. In window 31 on both DCMs, if the pump has temperature sensor and/or motor protection, set temperature monitoring to (on). If not, set the window to (OFF). See Section 8.5, page 42.
9. In window 32 on both DCMs if window 31 is set to on. Temperature alarm latched (on). Temperature alarm not latched (OFF). See Section 8.5.
10. In window 41 on both DCMs, set the permitted phase asymmetry to between 5% and 50%. Phase asymmetry is turned off by pressing -, when the window shows 5%. To turn the monitoring on again, press + and select a value. See Section 8.2, page 41.
11. In window 42 on both DCMs if window 41 value is between 5 and 50% choose phase asymmetry alarm latched (on) or phase asymmetry alarm not latched (OFF) See Section 8.2.
12. In window 51 on the SLAVE DCM, set the alarm relay contact function to NO (normally open) or NC (normally closed), see Section 7.1.3, page 35.
13. In window 52 on both DCMs, set the operating relay contact function. See Section 7.1.5.
14. In window 53 on both DCMs, set the required function for the digital input (DIG), value (1) high-level switch, (2) external reset, see Section 7.1.4, page 35.
15. Connect the start and stop equipment to terminal 8, see Fig. 16, page 34.
16. Check that one of the pumps is running according to the setting in window 13 and that the other pump is not running (set the stop level in window 11 to 0 (default) if the pump stops before or during the Auto set). Press the  button for 3 seconds until "SEt" is shown in the window. Press the  button on the other DCM. Wait until the start delay has elapsed. Press the  button for 3 seconds until "SEt" is shown in the window. The stop level becomes measured power (window 04) minus snore margin (window 12) if window 13 is set to (-). The stop level becomes measured power (window 04) plus snore margin (window 12) if window 13 is set to (). See Fig. 1, 2 and 12.

17. Change the level setting in window 21 on the MASTER DCM between 1 - 10 for shorter or longer pump cycles and level in the pit. A low value gives shorter pump cycles and lower level in the pit, see Fig. 11, page 23 and 14, page 32.
18. It is possible to avoid unintentional changes to set parameters. Set window 09 to 369 in each DCM and confirm with . A padlock is shown in the window. If the value 369 is re-entered in window 09 and confirmed by  the settings are unlocked.

7.3 Returning to the default settings

1. To return to the default settings go to window 99.
2. If any value differs from the default values (see Table 8), “U_{sr}” (set by the user) is displayed in the window.
3. Press  to return to the default settings. “dEF” (default setting) is shown in the window. Confirm by pressing .

NOTE: Also, windows 6, 7 and 8 are set to 0.

8 Protection and Alarm

When an error occurs, the triangular alarm sign starts to flash and the alarm relay is activated.

Window 00 becomes active and gives the information about the alarm according to the alarm list, see Table 6, page 41.

Alarm in a dual-pump application

The fault code is shown in window 00 of the respective DCM, the alarm relay is only set on terminal 6 of the DCM SLAVE when an error occurs. If a latched alarm occurs it must be reset on the respective DCM by pressing the  button or, if specified as digital input, by an external reset.

8.1 Phase sequence (F1)

When the DCM is first switched on, phases L1, L2 and L3 are checked for correct phase sequence.

If the wrong phase sequence is detected, an F1 alarm is generated and the ALARM relay on terminal 6 is activated. The pump will not start. Switch the power off and shift phase L2 and L3.

NOTE: Do not shift L1, only shift phase L2 and L3.

8.2 Phase asymmetry (F2)

The permitted phase asymmetry is set in window 41, see Table 8, page 53. Any failure shorter than 5 seconds is ignored. When phase asymmetry is detected an F2 alarm is generated and the ALARM relay on terminal 6 is activated. The pump will be stopped.

If window 42 is set to **on**, the alarm can be reset by pressing the  button or by using the external reset signal.

8.3 Checking the current (F3)

When  is pressed the DCM checks the measured current from the current transformer (CTM), see Table 1, page 15 or 2, page 17.

The measured current at terminals S1 and S2 is displayed in window 61. If the measured current is below 10 mA or above 60 mA, an F3 alarm is generated and the alarm relay is activated. The pump will be stopped.

8.4 Operating fault (F4)

If the pump is snoring and the high-level switch gives the signal to pump, this is a fault situation and an F4 alarm is generated and the ALARM relay is activated. If communication between the DCM MASTER and the DCM SLAVE is interrupted an F4 alarm is generated and the ALARM relay is activated. See Fig. 16, page 36 and Section 7.1.4, page 37.

8.5 Temperature input (F5)

Temperature monitoring on pump motor

The Emotron DCM can use either an input thermistor (PTC) signal or thermo contact (terminal 5). To activate temperature monitoring, set window 31 to “on”.

When the pump motor gets hot, the excess temperature generates an F5 alarm and activates the ALARM relay and the pump will be stopped.

It is also possible to connect a motor protection relay to generate an F5 alarm. See Fig. 13, page 27 and Fig. 16, page 36.

If window 32 is set to **on**, the alarm can be reset by pressing the RESET button or by using the external reset signal.

8.6 Undervoltage (LU)/Overvoltage (OU) alarm

When the Emotron DCM is first switched on, the voltages on phases L1, L2 and L3 are checked.

If the wrong phase voltage is detected, an LU (undervoltage) or OU (overvoltage) alarm is generated and the ALARM relay is activated. The pump will not start. Switch the power off. Check that the line voltage corresponds to the voltage range of the DCM according to the rating plate on the side of the unit.

Table 6 Alarm indications

| Indication | Function | Remark |
|-------------------|----------------------|--------------------------|
| F1 | Phase sequence | See Section 8.1, page 39 |
| F2 | Phase asymmetry | See Section 8.2, page 39 |
| F3 | Checking the current | See Section 8.3, page 40 |
| F4 | Operating fault | See Section 8.4, page 40 |
| F5 | Temperature input | See Section 8.5, page 40 |
| LU | Undervoltage | See Section 8.6, page 41 |
| OU | Overvoltage | See Section 8.6, page 41 |
| oor | Out of range | See Chapter 9, page 45 |

9 Troubleshooting

| | |
|---------------------------|---|
| Window 00 shows F1 | Phase sequence alarm, see Section 8.1, page 41. |
| Window 00 shows F2 | Phase asymmetry alarm, see Section 8.2, page 41. |
| Window 00 shows F3 | Current input alarm, see Section 8.3, page 42. |
| Window 00 shows F4 | Operating fault, see Section 8.4, page 42. |
| Window 00 shows F5 | Temperature input, see Section 8.5, page 42. |
| Window 00 shows LU/ OU | LU Undervoltage or OU Overvoltage alarm, see Section 8.6, page 43. Check that the line voltage corresponds to the voltage range of the Emotron DCM according to the rating plate on the side of the unit. |



WARNING!

Switch off the main supply before any wires, etc., are disconnected or connected!

| Problem | Solution |
|--|--|
| “oor” (out of range) is shown in the window. | Means that the value is too high to be presented on the display. |
| Impossible to perform Auto set. | It is impossible to perform Auto set during the start-up delay period, if an alarm indication is present or both pumps are running. |
| The pump starts pumping at the wrong pit level. | Change the setting in window 21, see Note on page 22. |
| The pump stops although it is pumping without snoring. | Check the stop level value in window 11. This value is probably too high in relation to measured power in window 04, see Fig. 4, page 13 or Fig. 5, page 14. |
| The pump does not stop when snoring. | Check the stop level value in window 11. This value is probably too low in relation to measured power in window 04, see Fig. 4, page 13 or Fig. 5, page 14. |

| Problem | Solution |
|---|--|
| The value in window 04 increases when the pump starts to snore. | Check that the current transformer(s) is/are linked to the phase connected to terminal 9 (L1), see Section 6.1.2 and Fig. 13 or Section 7.1.2 and Fig. 16. |
| Power range | The power is represented as a value between 0-125% of the "DCM's power range". |
| Overflowing pit | The DCM is designed to work with a pit volume which is \geq the capacity of the pump (in litres), see Note on page 22. |
| "Over-dimensioned" pump | The capacity of the pump is too high. This will cause the pump time to shorten compared with the pause time (the pause time will lengthen). The calculated pause time is based on previous pause time, actual pump time and the setting of window 21 (1-10). |
| The pump continues to run even if an alarm is active. | If alarm F4 (operating fault) has occurred, the pump will continue to pump until the user resets the alarm. |

10 Technical Data

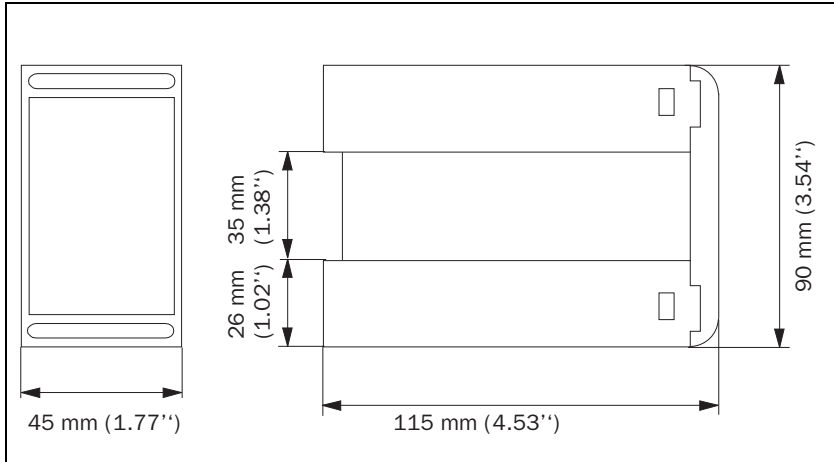

Fig. 17 DCM dimensions

Table 7 Technical data

| | |
|-----------------------------|--|
| Dimension (WxHxD) | 45 x 90 x 115 mm (1.77" x 3.54" x 4.53") |
| Mounting | 35 mm DIN rail 46277 |
| Weight | 0.3 kg (10.5 oz) |
| Supply voltage (VAC) | 3 x 100 to 240, 3 x 380 to 500, 3 x 525 to 690 ($\pm 10\%$) NOTE: that these are separate voltage units; see table with order numbers on page 47. |
| Frequency | 45 to 65 Hz |
| Current input | Current transformer CTM010, 025, 050 or 100. (If rated current >100 A, CTM010 and a standard transformer) |
| Power consumption | 6 VA max. |
| Start-up delay | 1 to 170 s |

Table 7 Technical data

| | |
|--|---|
| Stop delay | 1 to 90 s |
| Digital input terminal 3 | For closing contact. Internal supply 15 - 30 VDC, short-circuit current 10 - 20 mA |
| Temperature input terminal 5 | Internal supply 15-30 VDC, short-circuit current 2 mA - 2.5 mA |
| Relay output | 5 A 240 VAC Resistive. 1.5 A 240 VAC Pilot duty/AC12 |
| Fuse | 10 A max. |
| Terminal wire size | Use 75°C copper (CU) wire only. 0.2 to 4.0 mm ² single core (AWG12), 0.2 to 2.5 mm ² flexible core (AWG14), stripped length 8 mm (0.32"). |
| Terminal tightening torque | 0.56 - 0.79Nm (5-7 lb-in) |
| Repeatability power measurement | ±1 unit 24 h; +20°C (+68°F) |
| Temperature tolerance | < 0.1% / °C |
| Operating temperature range | -20°C to +50°C (-4°F to +122°F) |
| Storage temperature range | -30°C to +80°C (-22°F to +176°F) |
| Protection class | IP20 |
| RoHS directive | 2002/95/EC |
| Approved to | CE (up to 690 VAC), UL and cUL (up to 600 VAC) |

Order number

| Order number | Designation |
|--------------|---------------------------|
| 01-2110-25 | Emotron DCM 3x100-240 VAC |
| 01-2110-45 | Emotron DCM 3x380-500 VAC |
| 01-2110-55 | Emotron DCM 3x525-690 VAC |

Technical data for current transformer (CT)

| Type | Dimensions (WxØ) | Weight* | Mounting |
|---------|------------------|---------|----------------------|
| CTM 010 | 27 (35) x Ø48 mm | 0.20 kg | 35 mm DIN rail 46277 |
| CTM 025 | 27 (35) x Ø48 mm | 0.20 kg | 35 mm DIN rail 46277 |
| CTM 050 | 27 (35) x Ø48 mm | 0.20 kg | 35 mm DIN rail 46277 |
| CTM 100 | 45 (58) x Ø78 mm | 0.50 kg | 35 mm DIN rail 46277 |

*Weight including 1 m (39 inch) cable. Please note that the maximum length of the CTM cable is 1 m and this cable must not be extended.

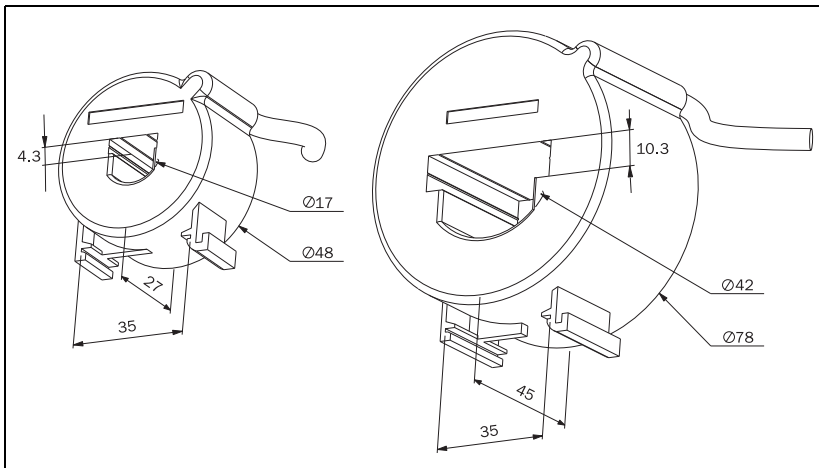

Accessories and documentation

| Order number | Designation |
|--------------|---|
| 01-2471-10 | Current Transformer (CT) CTM010, max. 10 A |
| 01-2471-20 | Current Transformer (CT) CTM025, max. 25 A |
| 01-2471-30 | Current Transformer (CT) CTM050, max. 50 A |
| 01-2471-40 | Current Transformer (CT) CTM100, max. 100 A |
| 01-2368-00 | Front Panel Kit 1 (2x terminal covers included) |
| 01-4136-01 | 2x Terminal covers |
| 01-5965-00 | Instruction manual (Swedish) |
| 01-5965-01 | Instruction manual (English) |

Dismantling and disposal

The product is designed to comply with the RoHS directive, and should be handled and recycled in accordance with local legislations.

10.1 EU (European Union) specifications

| | |
|---|--|
| EMC | EN 61000-6-3 EN 61000-6-2 EN 61000-4-5 |
| Electrical safety | EN 60947-5-1 |
| Rated insulated voltage | 690 V |
| Rated impulse withstand voltage | 4000 V |
| Pollution degree | 2 |
| Terminals 3, 4 and 5 are basic insulated from the line and relay terminals. | |

10.2 US specifications

FCC (Federal Communications Commission)

This equipment has been tested and found to comply with the limits for a class A digital device pursuant to Part 15 of the FCC Rules. These limits are designed to provide reasonable protection against harmful interference when the equipment is operated in a commercial environment. This equipment generates, uses and can radiate radio frequency energy and, if not installed and used in accordance with the instruction manual, may cause harmful interference, in which case, the user will be required to correct the interference at their own expense.

10.3 Canada specifications

DOC (Department of communications)

This digital apparatus does not exceed the Class A limits for radio noise emissions from digital apparatus as set out in the Canadian Interference-Causing Equipment Regulations. Le présent appareil numérique n'émet pas de bruits radioélectriques dépassant les limites applicables aux appareils numériques de la classe A prescrites dans le Règlement sur le brouillage radioélectrique édicté par le ministère des Communications du Canada.

11 Window Parameters

Table 8 Window parameters and defaults





| Window | Function | Value | Default | Custom setting | |
|--------|---|--|---------|----------------|-------|
| | | | | Master | Slave |
| 00 | Alarm indication. Flashes when alarm present (window becomes active only on alarm). Symbol  flashing. | See Table 6, page 43. | | | |
| 01 | Remaining time to next pump start. Standard window during pause. When the DCM is SLAVE --- appears. Symbol  flashing and m (min) or s (second). | 720 - 15 min. 900 to 0 s | | | |
| 02 | Pumping Time (PT) since the last pump start. Displayed when pumping. When the DCM is MASTER and the DCM SLAVE is pumping --- appears. Symbol  flashing and m (min) or s (seconds). | 0 to 90 s. 15 - 720 min. 12 to 999 h | | | |
| 03 | Pumping Time (PT) after last pump start when the pump is started on high-level switch. Displayed when pumping after high-level switch. Symbol  flashing and m (min) or s (seconds). | 0 to 900 s 15 - 720 min. 12 to 999 h | | | |
| 04 | Measured power as percentage of the DCM's measurement range. Symbol %. | 0 to 125% | | | |

Table 8 Window parameters and defaults

| Window | Function | Value | Default | Custom setting | |
|--------|--|------------|---------|----------------|-------|
| | | | | Master | Slave |
| 05 | Measured line voltage. Symbol V. | 0 to 999 V | | | |
| 06 | Measured peak power as percentage of the DCM measurement range. Press - and + (in this window) simultaneously for 3 seconds to reset the value. Symbol %. | 0 to 125% | 0% | | |
| 07 | Total pumping time in hours. Press - and + (in this window) simultaneously for 3 seconds to set the value to 0. Symbol ⌚. | 0-99999 | 0 | | |
| 08 | Total number of pump starts. Press - and + (in this window) simultaneously for 3 seconds to set the value to 0. | 0-99999 | 0 | | |
| 09 | Parameter lock. Symbol  . Is displayed when parameter is locked. | 0 to 999 | | | |
| 11 | Stop level. Symbol %. | 0 to 125% | 0% | | |
| 12 | Snore margin. Symbol %. | 0 to 125% | 4% | | |
| 13 | Type of Auto set. Auto set when the pump is snoring (⌋) (No liquid in the pit). Auto set when the pump is not snoring (⌋) (Liquid in the pit). | (⌋) or (⌋) | (⌋) | | |

Table 8 Window parameters and defaults

| Window | Function | Value | Default | Custom setting | |
|--------|---|-----------------------------|---------|----------------|-------|
| | | | | Master | Slave |
| 21 | Pit volume and level setting, see Fig. 11, page 23 and Fig. 14, page 32. See also note on page 22. NOTE! The window is not shown when the DCM is SLAVE. | 1.0 to 10.0 | 1.0 | | |
| 22 | Maximum pause time. NOTE! The window is not shown when the DCM is SLAVE. Symbol ⏴. | 0 to 900 s 15 - 720 min. | 600 s | | |
| 23 | Start-up delay. Symbol ⏴. | 1 to 170 s | 5 s | | |
| 24 | Stop delay. Symbol ⏴. | 1 to 90 s | 2 s | | |
| 31 | High temperature on pump motor or motor protection alarm, terminal 5 (on). Turn off (OFF). | on / OFF | OFF | | |
| 32 | Latched alarm, terminal 5 (on). Alarm not latched (OFF). Can only be used when window 31 is (on). | on / OFF | OFF | | |
| 41 | Phase asymmetry permitted. | OFF/ 5 to 50% | 10% | | |
| 42 | Phase asymmetry latched alarm (on). Phase asymmetry alarm not latched. (OFF) Can be used when window 41 is set between 5-50%. | on / OFF | OFF | | |

Table 8 Window parameters and defaults

| Window | Function | Value | Default | Custom setting | |
|--------|--|---------|---------|----------------|-------|
| | | | | Master | Slave |
| 51 | Alarm relay (terminal 6 ALARM). NC: normally closed, NO: normally open. The window isn't shown when DCM is MASTER | NC/NO | NO | | |
| 52 | Operating relay to control the pump motors contactor (terminal 8 PUMP). NC: Relay contact is closed when pump is pumping. NO: Relay contact is open when pump is pumping. | NC/NO | NC | | |
| 53 | Digital input for closing contact: 1 High-level switch 2 External reset 3 External Auto set (not used in dual-pump system). | | 1 | | |
| 61 | Measured current on the terminals S1 and S2. | 0-70 mA | | | |
| 71 | Desired DCM function: 1 Single-pump system 2 Dual-pump system MASTER 3 Dual-pump system SLAVE. | 1, 2, 3 | 1 | | |
| 72 | Pump alternating: (on) Alternate by each pump cycle (OFF) The SLAVE DCM only starts when the DCM MASTER indicates a fault code. NOTE! The window is not shown when the DCM is SLAVE. | on/OFF | OFF | | |

Table 8 Window parameters and defaults

| Window | Function | Value | Default | Custom setting | |
|--------|--|---------|---------|----------------|-------|
| | | | | Master | Slave |
| 73 | Pump starts on high-level switch. (on) Both pumps start. (OFF) one pump starts. NOTE! Window is not shown when the DCM is SLAVE. | on/OFF | OFF | | |
| 99 | Default settings (dEF). User adjustments mode (USr). | dEF/USr | dEF | | |

12 Service

This manual is valid for the following model:

Emotron DCM (as from software version r1d)

NOTE: The Emotron DCM does not contain any user-serviceable parts. Breaking the seal over the front panel and housing will invalidate the warranty.

| | |
|-------------------|------------|
| Document number: | 01-5965-01 |
| Document version: | r1 |
| Date of release: | 2013-05-27 |

CG Drives & Automation Sweden AB reserves the right to alter product specifications without prior notification. No part of this document may be reproduced without permission from CG Drives & Automation AB.

For more information contact your local sales outlet or visit us at:
www.emotron.com/www.cgglobal.com

Protected by utility patents EP 1027759 and US 6879260

13 Appendix

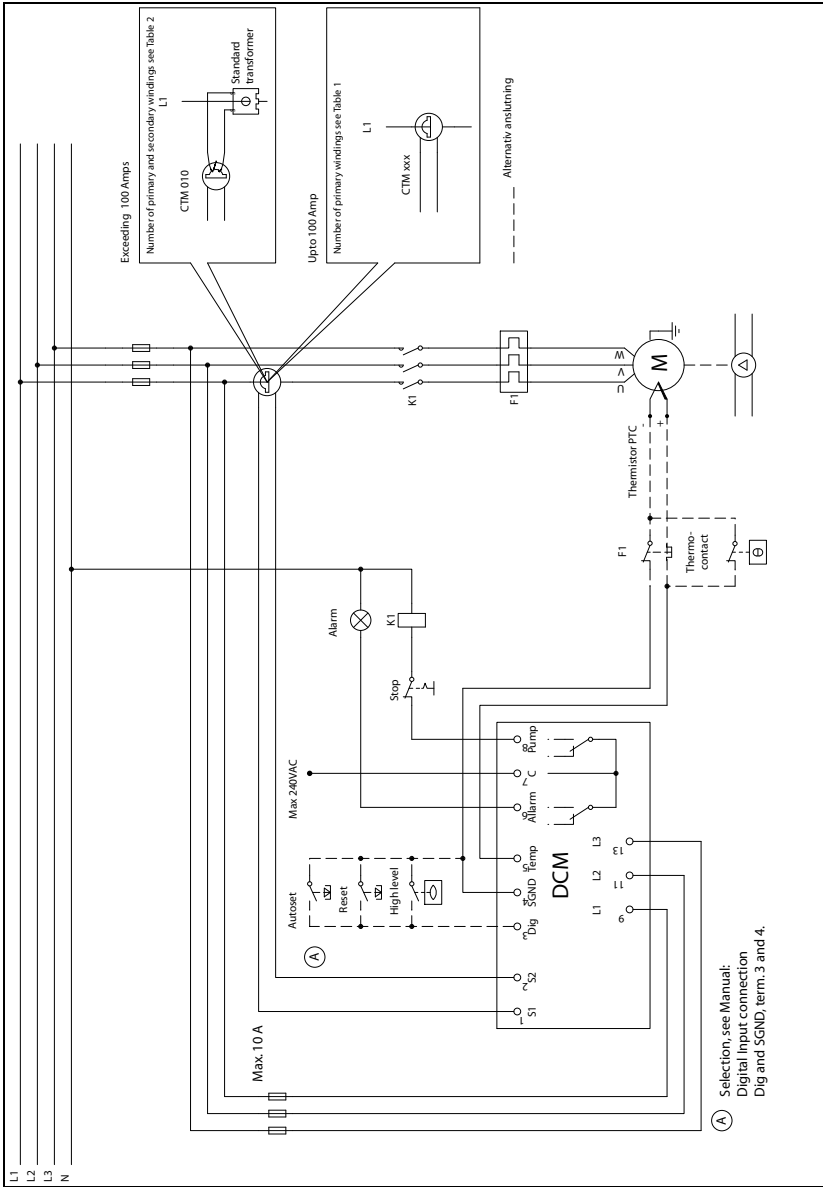

Fig. 18 Single-pump system installation example (Figure 13)

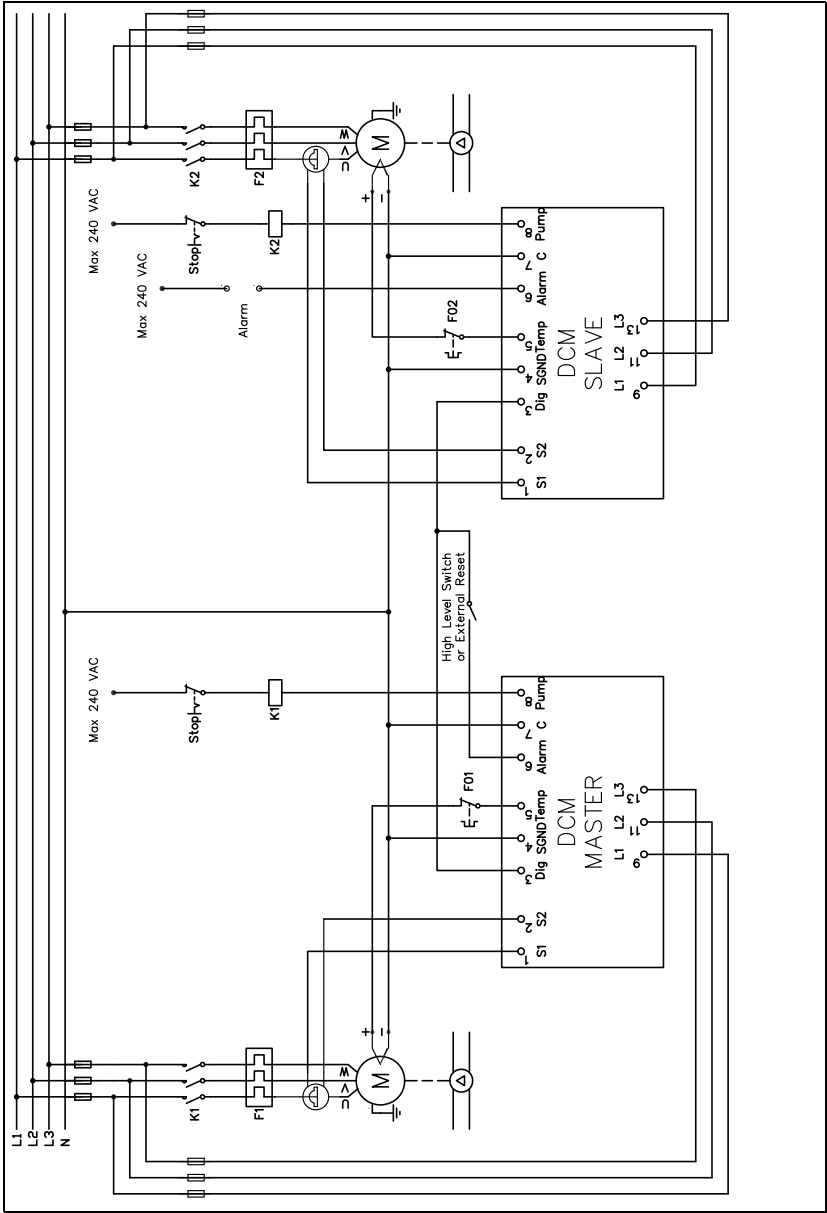

Fig. 19 Dual-pump example (Figur 16)

CG Drives & Automation Sweden AB
Mörsaregatan 12
Box 222 25
SE-250 24 Helsingborg
Sweden
T +46 42 16 99 00
F +46 42 16 99 49
www.cgglobal.com / www.emotron.com

CG Drives & Automation 01-5965-01r1 2013-05-27